

90° Glass-Glass click-on hinge. RIGATO. 8-10 mm glass thickness. Maximum door weight 50 kg, maximum width 1000 mm. Over 40 kg weight or 900 mm width, 3 hinges are recommended, within the maximum limits.



### TECHNICAL FEATURES

- **Height:** 59 mm
- **Width:** 102 mm
- **Depth:** 59 mm
- **Maximum supported weight:** 50 kg
- **Hinge rotation angle:** 90° outside/inside
- **Automatic closing angle:** 0 - 15°
- **Zero door offset adjustment:** +- 3°
- **Maximum leaf width:** 1000 mm
- **Installation screw visibility:** Concealed mounting
- **Glass thickness:** 8 mm - 10 mm
- **Texture:** Rigato

### CERTIFICATIONS

Production managed by a certified Quality System compliant with ISO 9001:2015 For additional approved contact Gessi S.P.A.

### TECHNICAL PRESCRIPTION

- For Glass width under 90 cm and Glass Weight under 40 kg 2 hinges are sufficient For Glass width between 90 and 100 cm or glass weight between 40 kg and 50 kg 3 hinges are required

### INDICATIONS FOR CLEANING

Clean only with a new microfiber cloth and soapy water and dry with a dry cloth. Detergents, solvents, alcohol, abrasive sponges, wire, wool, alcohol, etc., should not be used as these could irreparably damage product surfaces compromising its aesthetics and brilliance.

### ACCESSORIES AND FITTINGS

For additional matching bathroom accessories and fittings available, see official Gessi price list.

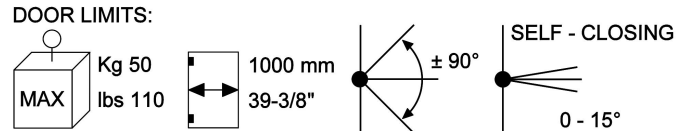
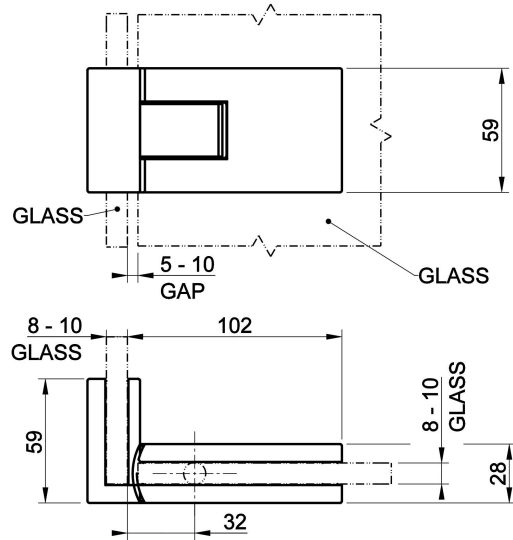



## FINISHES CHARACTERISTICS

### CHROME

Gessi products have a Chromium Plating finish. This is a high-quality coating composed of a first layer of nickel, a second layer of chromium, a very shiny appearance, high resistance to corrosion and abrasion.

### LAQUERED

Gessi products have an industrial lacquer finish. This coating is obtained by means of a special industrial process that involves spraying the lacquer onto the product with a subsequent firing process at a high temperature. The lacquer used is of the highest quality and ensures maximum resistance and durability. The different lacquer types depend on the product type.

### PVD COLORS

Gessi products have a PVD finish. This coating is obtained through the PVD (Physical Vapour Deposition) process, which is a state-of-the-art coating process that is highly resistant to abrasion and corrosion. The process is carried out in a vacuum chamber, where the material to be deposited is heated and vaporized, and then condensed onto the product to be coated. The result is a thin, uniform, and highly resistant film.

### STAINLESS STEEL

Gessi products have a solid Stainless Steel finish. This is a very high-quality finish, with a very high resistance to corrosion and abrasion. The finish is obtained by means of a special brushing process, which gives the product a very elegant and modern appearance. The finish is also very easy to clean and maintain.

For additional finishes contact Gessi S.P.A.